



Sensata
Technologies

**SENSOR
SOLUTIONS
FOR SMART
BUILDINGS**



We take pride in knowing that our technologies improve safety, efficiency and comfort for millions of people every day

For more than 100 years, we have provided a wide range of customized, sensor-rich solutions that address complex engineering requirements to help customers solve difficult challenges in many industries.

Our solutions help make products safer, cleaner, and more efficient and connected.

Table of Contents

Why Sensata

Solutions Overview

Applications

Heating, Air Conditioning, Refrigeration 5

Refrigeration Cycle

HVAC System Integration

Transport Refrigeration

Bus and Train Air Conditioning

Heat Pumps

Boilers

Water Management 11

Booster Pumps

Pump Controllers

Circulation Pumps

Smart Metering 14

Gas and Water Meters

Elevators and Access Control 15

Elevators

Access Control

The world demands increasing safety, energy efficiency and energy savings

Facilities around the world are a main contributor to global energy consumption. HVAC systems play a significant part in energy consumption and that's where Sensata can help you build cleaner and more efficient applications. Our sensors help increase energy efficiency and system reliability, are compatible with most environmentally friendly refrigerants and enable greater connectivity. We also have products designed specifically for hydronic applications, having a deep understanding of the role boilers, pump systems and smart meters play in a sustainable building.

We manufacture millions of sensors every year for mission-critical, hard-to-do applications. We get involved very early in the design process, right from the concept level, and we partner with you to achieve more competitive products while meeting regulations. Our team of engineers have the experience and expertise to innovate and problem solve no matter what your sensor challenges are.

Within the very complex area of smart buildings, our sensors will help you achieve more efficient pumps, boilers, home heating solutions, air conditioning and refrigeration systems, access control applications, and more. Together with you, we enable a cleaner and more efficient world.

SAFE | CLEAN | EFFICIENT | COMFORTABLE

Why Sensata

Sensata has a deep knowledge and understanding of a broad range of industrial applications and offers advice and support to help customers select the right products for your applications. Sensata takes pride in the flexibility of its operations to produce exceptional products which can be customized on a global scale.



Industry-specific knowledge and proprietary technology in mission critical and hard-to-do applications



Partnership mindset and flexible technology building blocks configured for customized solutions



Low cost manufacturing model with concentrated manufacturing operations across the globe



Strong teamwork to deliver fast responses to customers, with deep understanding of product design cycles and launch execution

What Our Customers Say

Vaillant Group, global leader in Heating, Ventilation and Air Conditioning technology

“After more than 5 years of common business relationship we would like to summarize our cooperation with Sensata Technologies as follows: from the beginning we looked for an innovative partner for Vaillant Group, capable to fulfill all our technical requirements. Vaillant Group has very high quality standards and stringent policies to validate new suppliers and we found in Sensata a professional partner capable to fulfill our requirements and also capable to adapt their products and production processes to our needs.

Together with the good technical support we received also a very professional and personal customer service. This has been the basis for a very strong cooperation and from the beginning we have grown together in the new Heat Pump market segment. It is worth mentioning the support given by Sensata to certify all the components according to the new requirements coming from the new F-gas regulation with the use of natural refrigerants. In summary, good technical support, always offering the last technologies and certifications with competitive prices, good quality and a professional custom service.”

Fast Facts

2020 Net Revenues: \$3B

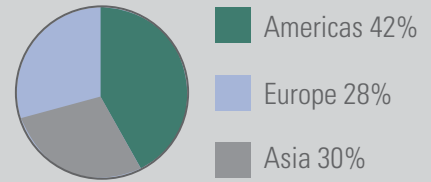

47,000+

different products
manufactured

1.1B

devices shipped each year,
each highly engineered

19,000

employees worldwide

11

countries with business centers
and manufacturing sites

Solution Overview

	Pressure Sensors	Pressure Switches	Thermostats	Position Sensors and Encoders	Motor Protectors	Solid State Relays
Refrigeration Cycle	•	•	•		•	•
HVAC System Integration	•	•	•		•	•
Transportation Refrigeration	•	•	•		•	•
Bus/Train Air Conditioning	•	•	•		•	•
Boilers	•		•			
Heat Pumps	•	•	•		•	•
Booster Pumps	•				•	•
Pump Controllers	•					
Circulation Pumps	•				•	
Gas Meters	•					
Water Meters	•					
Fire Hydrants	•					
Elevators				•		
Access Control				•		•

Functional Solutions

Pressure Sensors

Broad portfolio of pressure products based on a variety of proven technologies. From pressure sensors that offer ranges from 1 inch H2O to 10,000 psi or vacuum up to 600 bar, to our highly reliable pressure switches with a wide range from 0 – 2000 psi or 0 – 140 bar, our pressure solutions provide the configurability and performance needed for demanding industrial applications.

Temperature Sensors

Sensata’s comprehensive range of thermal solutions can meet many electrical protection needs. Its portfolio is easily configurable and includes rugged industrial thermostat switches and temperature sensors, with a wide range of form factors and connection options. Sensata is a global leader in high temperature exhaust gas sensing with solutions approaching 850°C.

Position Sensors and Encoders

Sensata’s comprehensive encoders and position sensors line includes incremental and absolute encoders, hall effect sensors, rotary and linear potentiometers as well as inclinometers and draw wire solutions.

We provide reliable and rugged products designed for use in standard industrial to heavy duty and hazardous area applications.

Motor Protectors

These products, including magnetic hydraulic circuit breakers, ground fault circuit interrupters, power switches and fuses, accurately provide protection against fault conditions and provide for the distribution and control of electrical power. Innovative design, proven performance, and quality manufacturing has made the Airpax™ brand the recognized leader in the markets we serve.



Refrigeration Cycle for Residential and Commercial Air Conditioning and Refrigeration Systems

Sensata's pressure sensors ensure higher efficiency in air conditioning and refrigeration system operation, allowing real time monitoring, system automation and maintenance feedback, while switches and thermostats provide the crucial safety factor.

Air conditioning manufacturers are increasingly confronted with complex design challenges due to stricter regulations, demanding HVAC environments, lower leakage rates, and the move to lower global warming potential and natural refrigerants.

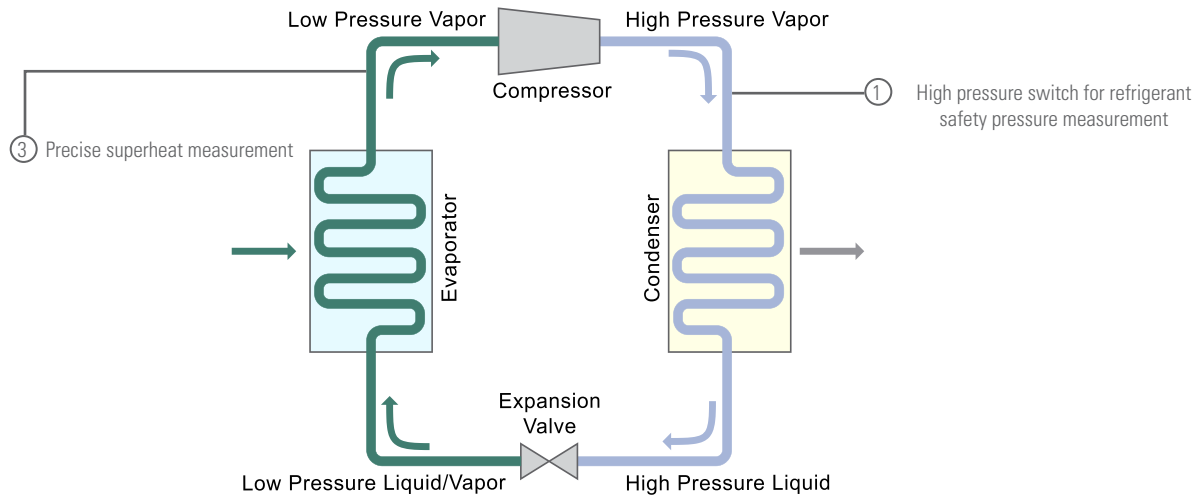
For large facilities like office buildings, hospitals, restaurants, hotels and other public locations, rooftops and chillers are widely used for cooling buildings. They are complex, costly systems, that consume more energy than any other piece of equipment in large buildings, therefore operating them smartly can lead to important energy and cost savings. Food waste reduction, decentralization of supermarkets and refrigerated food storage units, and the need to lower the overall carbon footprint are driving huge shifts in the supermarket refrigeration sector. Strategies include better control of pressure and temperature monitoring, minimizing refrigerant leakage, and better component selection such as compressors, heat exchangers, pressure and temperature sensors and controls.



	20PS, PS80, 25PS, 29PS Pressure Switches	<ul style="list-style-type: none"> • High quality standards and huge manufacturing scale and high-volume cost-effective supplier base • Automatic and manual reset; environmentally sealed or vented switch, hermetically sealed, high current 	High pressure switch for refrigerant safety pressure measurement
	2CP5, 35CP, 2HMP, PTE7100 Pressure Sensors	<ul style="list-style-type: none"> • Rugged seal ideal for outdoor environments, industry leading accuracy over broad temperature range. Hermetic sensor design with high dielectric strength • Huge manufacturing scale and high-volume cost-effective supplier base • Highly configurable, high accuracy, stainless steel housing, durable, compact, low-cost design 	Refrigerant system regulation
	112CP Pressure and Temperature Sensor	<ul style="list-style-type: none"> • Pressure and temperature measurement in one package • Fast, in-stream temperature measurement 	Precise superheat measurement
	1NT/3NT Thermostat	<ul style="list-style-type: none"> • Automatic reset, small and easy to mount, fast thermal response • Innovative dry seal design - protects from moisture and dust 	Precise overheat measurement with dry seal design thermostat
	LLF40 Series Compact Internal Fitting, Low Level, Low S.G. Float Switch	<ul style="list-style-type: none"> • Suitable for low specific gravity liquids (0.7 S.G.) • Very low level sensing. Class leading compact design • Available in Nylon, Polypropylene, PPS or PVDF. 25VA & 100VA versions 	Indicates level changes in shallow water in condensate trays
	RSF50 Vertical Plastic Float Switch with Internal Mount	<ul style="list-style-type: none"> • Compact Design. M12 or 1/8NPT mounting thread • User configurable N/O or N/C operation. WRAS and NSF approved variants • Available in PPS, Polypropylene, Nylon and PVDF 	Compact fitting float switch for condensate tray level control
	RSF40, RSF70 Compact Internal Fitting Float Switch	<ul style="list-style-type: none"> • Compact Design. WRAS and/or NSF approved versions available • Reliable reed switch contacts; available in Nylon, Polypropylene, PPS and PVDF 	Condensate tray level control





HVAC System Integration

A key driver in the implementation of energy efficient and sustainable climate control in buildings is system integration.

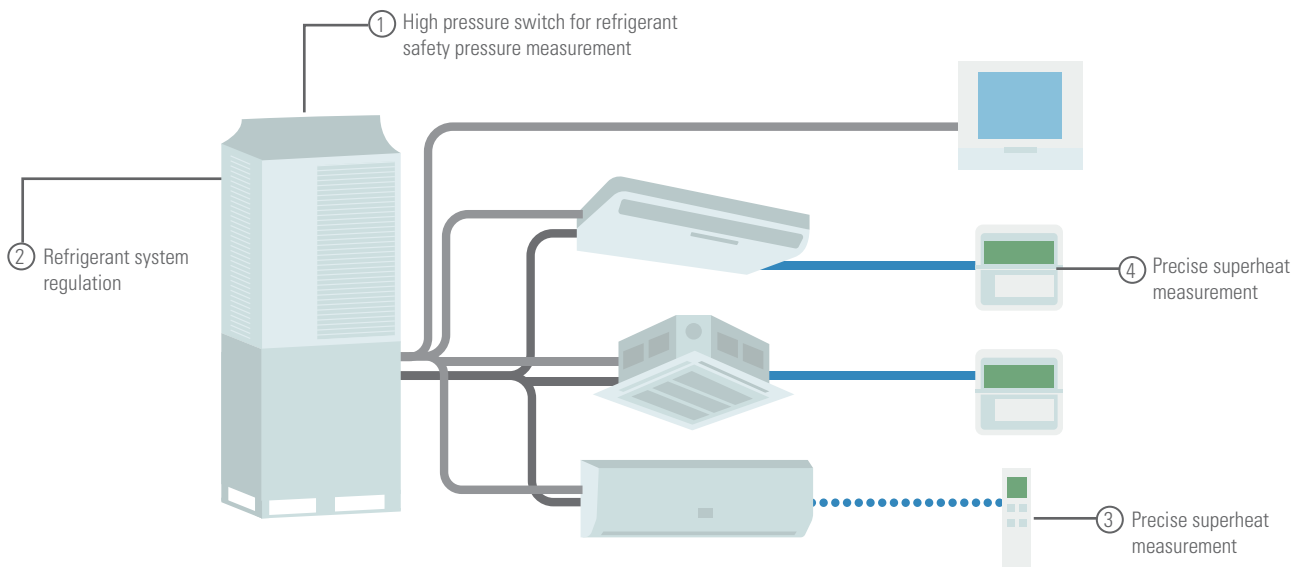
Sensata works closely with leading control unit manufacturers and system integrators, creating value for end users and OEMs through packaged sales of sensors and controllers, programmed to communicate with one another.

Sensata manufactures reliable sensors for the regulation of HVAC/R systems fine tuned to communicate with building automation controllers and software.



	<p>20PS, PS80, 25PS, 29PS Pressure Switches</p>	<ul style="list-style-type: none"> • High quality standards, huge manufacturing scale and high-volume cost-effective supplier base • Automatic and manual reset; environmentally sealed or vented switch, hermetically sealed, high current 	<p>High pressure switch for refrigerant safety pressure measurement</p>
	<p>2CP5, 35CP, 2HMP, PTE7100 Pressure Sensors</p>	<ul style="list-style-type: none"> • Rugged seal ideal for outdoor environments, industry leading accuracy over broad temperature range. Hermetic sensor design with high dielectric strength • Huge manufacturing scale and high-volume cost-effective supplier base • Highly configurable, high accuracy, stainless steel housing, durable, compact, low-cost design 	<p>Refrigerant system regulation</p>
	<p>112CP Pressure and Temperature Sensor</p>	<ul style="list-style-type: none"> • Pressure and temperature measurement in one package • Fast, in-stream temperature measurement 	<p>Precise superheat measurement</p>
	<p>1NT/3NT Thermostat</p>	<ul style="list-style-type: none"> • Automatic reset, small and easy to mount, fast thermal response • Innovative dry seal design - protects from moisture and dust 	<p>Precise superheat measurement</p>

Transport Refrigeration

Sensata pressure and temperature sensors and switches, help mobile cooling systems operate efficiently, safely and continuously.

Refrigerated transport solutions are a vital part of the logistics world, reducing food waste, and keeping other goods such as refrigerated medical supplies safe during transport.

Sensata partners with the leading transport refrigeration manufacturers globally to continually make these systems more efficient and ensure goods stay cooled for the entire journey.

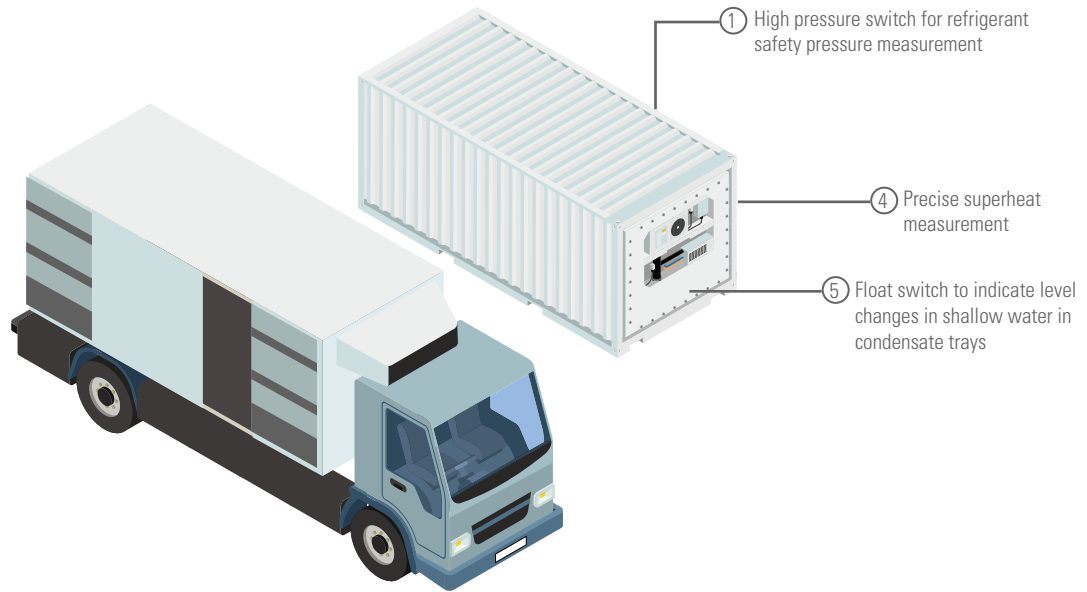

	<p>① 20PS, PS80, 25PS, 29PS Pressure Switches</p>	<ul style="list-style-type: none"> • High quality standards, huge manufacturing scale and high-volume cost-effective supplier base • Automatic and manual reset; environmentally sealed or vented switch, hermetically sealed, high current 	<p>High pressure switch for refrigerant safety pressure measurement</p>
	<p>② 2CP5, 35CP, 2HMP, PTE7100 Pressure Sensors</p>	<ul style="list-style-type: none"> • Rugged seal ideal for outdoor environments, industry leading accuracy over broad temperature range. Hermetic sensor design with high dielectric strength • Huge manufacturing scale and high-volume cost-effective supplier base • Highly configurable, high accuracy, stainless steel housing, durable, compact, low-cost design 	<p>Refrigerant system regulation</p>
	<p>③ 112CP Pressure and Temperature Sensor</p>	<ul style="list-style-type: none"> • Pressure and temperature measurement in one package • Fast, in-stream temperature measurement 	<p>Precise superheat measurement</p>
	<p>④ 1NT, 3NT Thermostat</p>	<ul style="list-style-type: none"> • Automatic reset, small and easy to mount, fast thermal response • Innovative dry seal design - protects from moisture and dust 	<p>Precise superheat measurement</p>
	<p>⑤ LLF40 Series Compact Internal Fitting, Low Level, Float Switch</p>	<ul style="list-style-type: none"> • Suitable for low specific gravity liquids (0.7 S.G.) • Very low level sensing. Class leading compact design • Available in Nylon, Polypropylene, PPS or PVDF. 25VA & 100VA versions 	<p>Float switch to indicate level changes in shallow water in condensate trays</p>
	<p>⑥ RSF50 Vertical Plastic Float Switch with Internal Mount</p>	<ul style="list-style-type: none"> • Compact Design. M12 or 1/8NPT mounting thread • User configurable N/O or N/C operation. WRAS and NSF approved variants • Available in PPS, Polypropylene, Nylon and PVDF 	<p>Diesel generator tank level control to allow the diesel generator to drive the refrigeration compressor when the truck is stationary</p>





Bus/Train Air Conditioning

The air-conditioning system, whose central unit is usually placed on the roof of busses and trains, ensures a comfortable climate for the passengers on board.

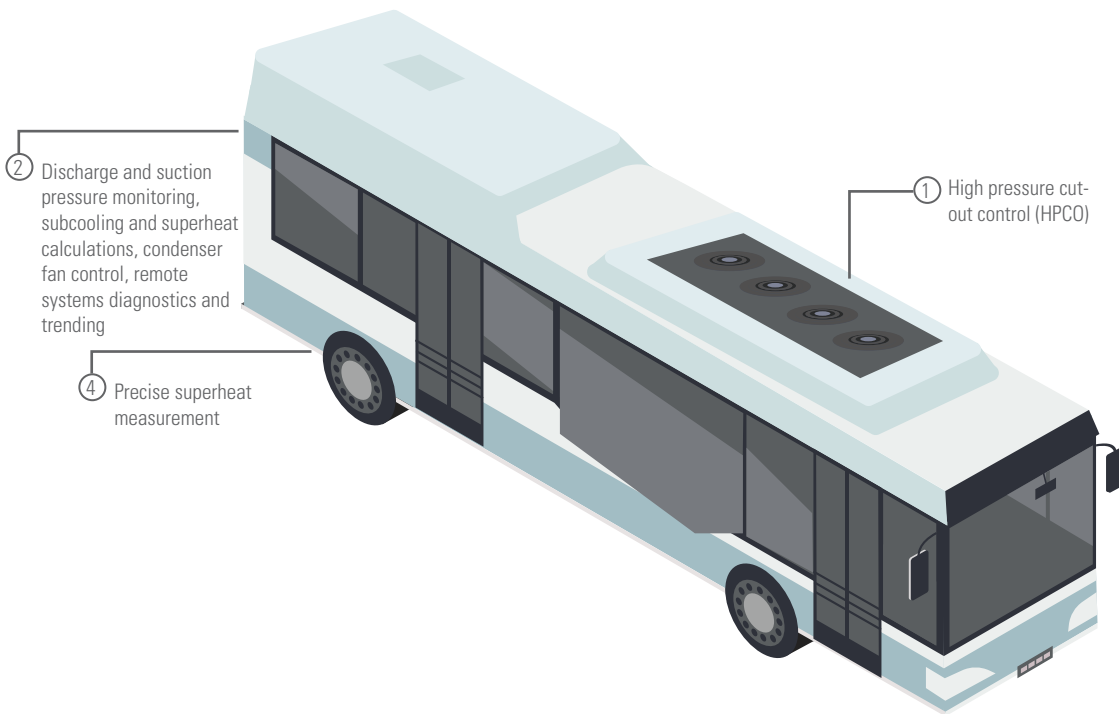
Sensata pressure sensors and switches play a decisive role in these systems. High energy efficiency and savings are achieved through intelligent control of the condenser fans and the compressor through sensors.

Sensors from Sensata help ensure passenger comfort and save energy.



	<p>20PS Pressure Switches</p>	<ul style="list-style-type: none"> • Automatic reset; environmentally sealed or vented switch; SPST switch normally open or normally closed • Dedicated cut-out pressure setting calibration in our factory 	<p>High pressure cut-out control (HPCO)</p>
	<p>Ceramic Capacitive Pressure Sensors</p>	<ul style="list-style-type: none"> • UL recognized, durable, compact, low-cost design, accurate performance over wide temperatures • Overvoltage and short circuit protected • ATEX certification for R290 and other flammable refrigerants 	<p>Discharge and suction pressure monitoring, subcooling and superheat calculations, condenser fan control, remote systems diagnostics and trending</p>
	<p>HVAC and Refrigeration Pressure Sensors for Outdoor Environments</p>	<ul style="list-style-type: none"> • Provides best in class accuracy over temperature, in a reliable, hermetic design at a competitive price • Media and electrical isolation protects against thermal and electrical shock 	<p>Refrigerant hermetic pressure</p>
	<p>112CP Pressure and Temperature Sensor</p>	<ul style="list-style-type: none"> • Pressure and temperature measurement in one package • Fast, in-stream temperature measurement 	<p>Precise superheat measurement</p>
	<p>PTE7100 Pressure Sensor</p>	<ul style="list-style-type: none"> • Highly configurable, high accuracy, stain steel housing; wide temperature range • Hermetic sensor design with optional connections on pressure and electrical side 	<p>Ensures the system regulation when the refrigerant is CO₂</p>

Heat Pumps





Sensata has a wide range of pressure sensors specifically designed for heat pumps using traditional refrigerants as well as propane, CO2 and other natural refrigerant types.

Heat pumps play a major role in renewable heating and cooling, using sources from the environment such as air, geothermal, and water to provide heat for space heating and sanitary hot water.

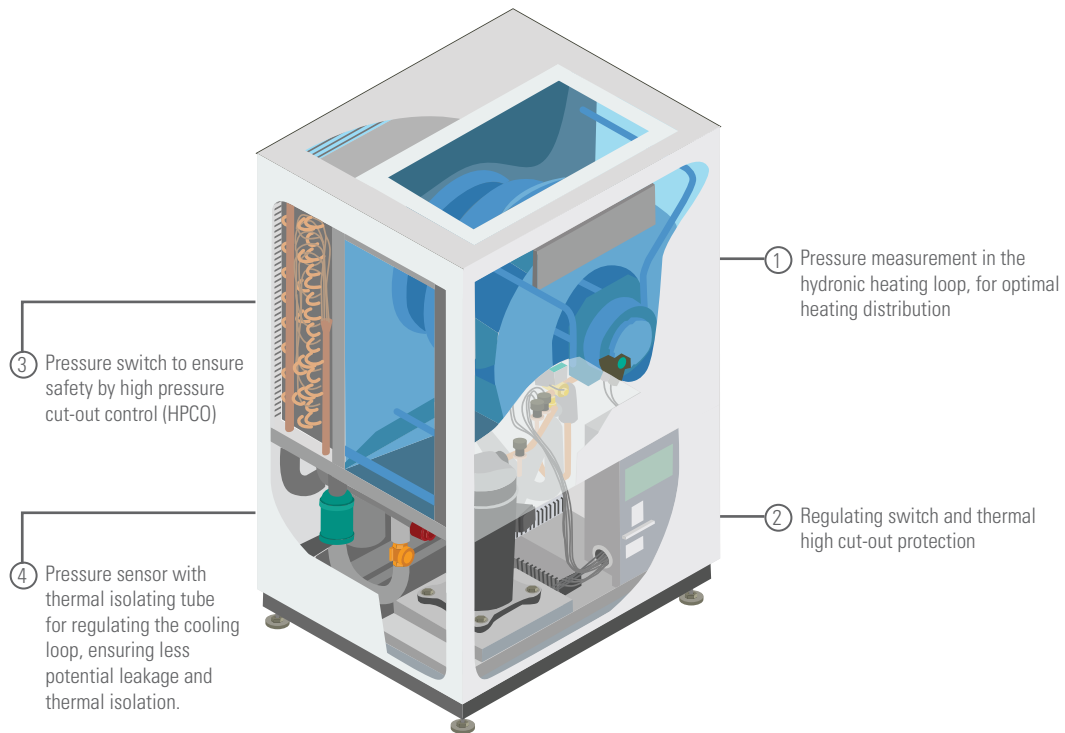
The installation of heat pumps in Europe plays a major role in global decarbonization initiatives by moving from heating sources that burn fossil fuels to systems using clean heat sources. In addition, trends to use natural refrigerants such as propane further contribute to environmental friendliness of these systems.

Sensata has a wide range of pressure sensors specifically designed for heat pumps using traditional refrigerants as well as propane, CO2 and other natural refrigerant types. Additionally, pressure switches, thermostats and temperature sensors offer a broad portfolio for heat pump applications.



①	 <p>116CP Pressure Sensor</p>	<ul style="list-style-type: none"> Water pressure sensor, including certifications for potable water Cost-efficient sensor due to the huge manufacturing scale and high-volume supplier base 	<p>Pressure measurement in the hydronic heating loop, for optimal heating distribution</p>
②	 <p>3NT Thermostat</p>	<ul style="list-style-type: none"> Small and easy to mount, high temperature resistant Highly reliable safety switch with ATEX certification for R290 and other flammable refrigerants 	<p>Regulating switch and thermal high cut-out protection</p>
③	 <p>PS80 Pressure Switch</p>	<ul style="list-style-type: none"> Automatic reset; environmentally sealed or vented switch; SPST switch normally open or normally closed Low cost pressure switch for stationary systems with ATEX certification 	<p>Pressure switch to ensure safety by high pressure cut-out control (HPCO)</p>
④	 <p>81/82CP Pressure Sensor</p>	<ul style="list-style-type: none"> ATEX and ISO14903 certifications for use with flammable refrigerants The sensor can be brazed directly in copper tubes 	<p>Pressure sensor with thermal isolating tube for regulating the the cooling loop, ensuring less potential leakage and thermal isolation.</p>

Boilers

Central boilers are a common way of heating the house or office. In the case where a combi-boiler is used, sanitary hot water is also heated from the same system. For example, wall hung boilers are energy and space efficient ways of heating rooms. Heat transfer is done by means of a hydronic system that transfers heat to the radiator panels in separate rooms. One important variable in the hydronic system is the liquid water pressure. If the pressure is too high, there is risk of damage or leakage to the hydronic system. If the pressure is too low, there is risk of damaging the heat exchanger inside the boiler.

Sensata offers a cost-effective, reliable and accurate pressure sensor to measure the pressure in the hydronic loop of the central heating boiler.

The pressure sensor's compact design makes it ideal for boilers where space can be an issue.

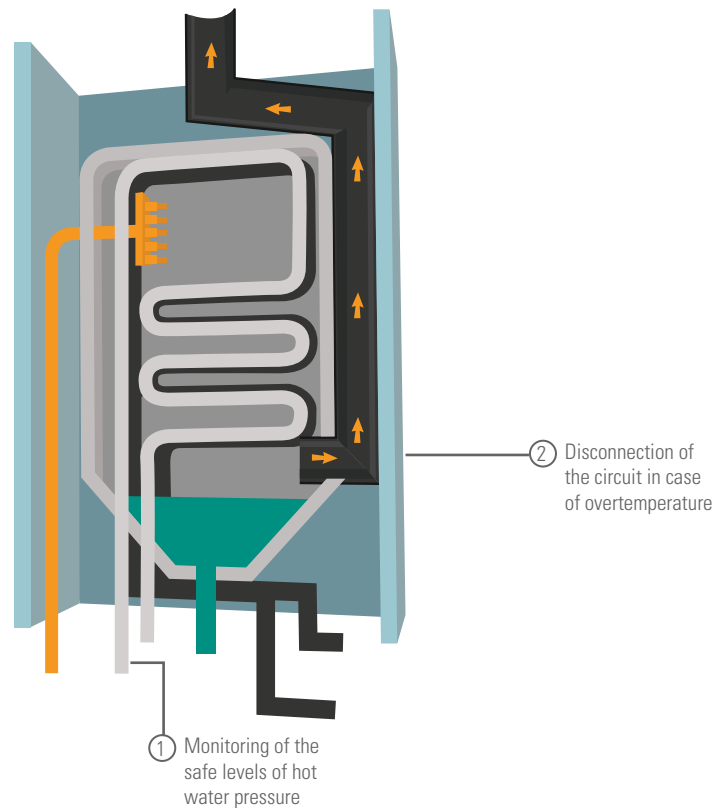

①



116CP
Pressure Sensor

- Accurate and reliable pressure measurement, offered in a compact plastic package
- REACH/RoHS compliant; 0-4 to 0-16 bar
- The sensor is designed for measuring pressure of liquid media

Monitoring of the safe levels of hot water pressure

②



1NT
Thermostats

- Due to the innovative dry seal design, the 3NT is ideal in systems where moisture build up is common
- -40°C to 240°C temperature rating, multiple switch actions available, ISO9001: 2000 certification

Disconnection of the circuit in case of overtemperature

Booster Pumps





In addition to energy savings there are reduced maintenance costs due to the system operating at reduced pressures

Booster pumps are a very common way of increasing water pressure in a home or office if the water is coming from a well or if the water pressure coming from the city is low.

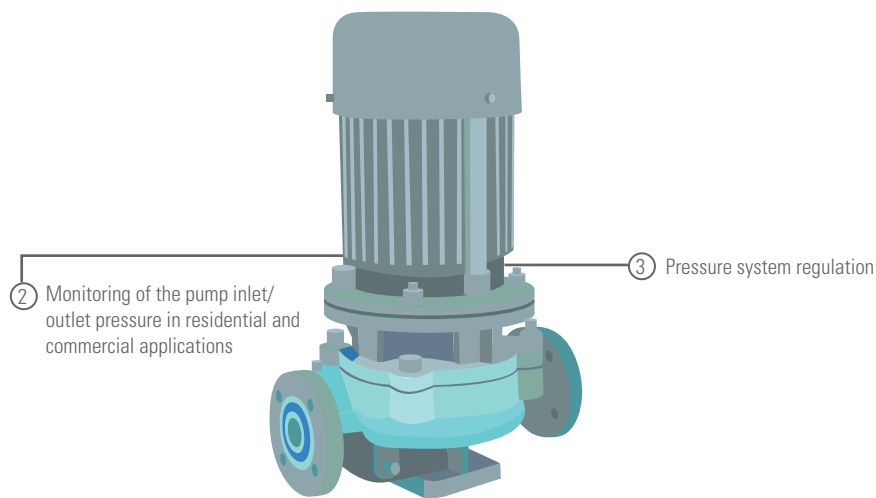
Water booster pumps also give pressure to move water through a residential or commercial building from a storage tank.

Increasing regulations and stronger focus on energy consumption has prompted OEMs to move to variable speed pumps, continuously optimizing the pump speed and power consumption while maintaining constant outlet pressure of the pump. Pressure sensors are a fundamental part to this system.



①	 <p>116CP, 126CP Pressure Sensors</p>	<ul style="list-style-type: none"> Multiple port & connector options, high accuracy, small & compact size Full automated calibration; drinking water safe options available 	Monitoring of the pump inlet/outlet pressure in residential and commercial applications
②	 <p>35CP Pressure Sensors</p>	<ul style="list-style-type: none"> Ideally suited for environmentally demanding industrial applications Their design requires no end user amplification; several housing options are available 	Monitoring of the pump inlet/outlet pressure in residential and industrial applications
③	 <p>PTE7100 Pressure Sensor</p>	<ul style="list-style-type: none"> Measuring range from 0-50 bar to 0-400 bar, wide range of ports, connectors, and electrical outputs Highly configurable, high accuracy, stainless steel housing with hermetic port 	Pressure system regulation
④	 <p>2AM/8AM Motor Protectors</p>	<ul style="list-style-type: none"> Small, light weight and sensitive to temperature and current It can be mounted directly on motor windings for fast detection of temperature changes 	Pump motor protection
⑤	 <p>FSP10 Flow switch</p>	<ul style="list-style-type: none"> Direct switching of pumps up to 4A inductive 0.6 or 3.0 l/min turn on flow rate Automatic shutdown on flow stop. 1" BSP pipe connections 	Controller incorporating a flow switch detects low flow preventing pumps running dry and incurring damage

Pump Controllers

Controllers are an essential part of a pump application, required to automate the pumping process in the system and operate at a specific speeds and pressures, continuously optimizing the pump speed and power consumption while maintaining constant pressure of the pump.

The sensor measurement pressure value is usually presented on the pump's display. In digital trends customers are able to view and monitor pressures via an application on their smartphone or tablet. In addition, a notification can inform users of irregularities and assist in preventative maintenance.

Sensata offers a cost-efficient pressure sensor with potable water certification.

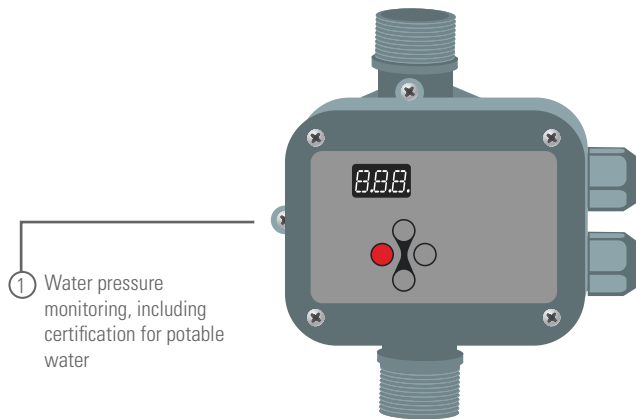

①  **116, 126CP Plastic Ceramic Capacitive Pressure Sensor**

- Utilizing Sensata's industry leading ceramic capacitive technology, this sensor is housed in a small and innovative plastic package ideal for boilers and pumps
- Offered in a wide range of configurations including various pressure ports, electrical outs and pressure ranges from 0-4 to 0-16 bar

Water pressure monitoring, including certification for potable water

②  **35CP Pressure Sensors**

- Packard and M12 connector, supply: 5Vdc or 6-30Vdc
- Stainless steel housing with 40bar max. pressure range, drinking water certifications available for specific products

Water pressure monitoring and control

Circulation Pumps





By monitoring pump discharge pressure in real-time, pressure sensors gauge the exact pumping need and adjust motor speed accordingly, helping pump systems to reach the lowest Energy Efficiency Index.

Hot water circulation pumps, also known as recirculation pumps, are installed on central heating systems to control the process of circulating the hot water from the boiler to the room radiators in a loop.

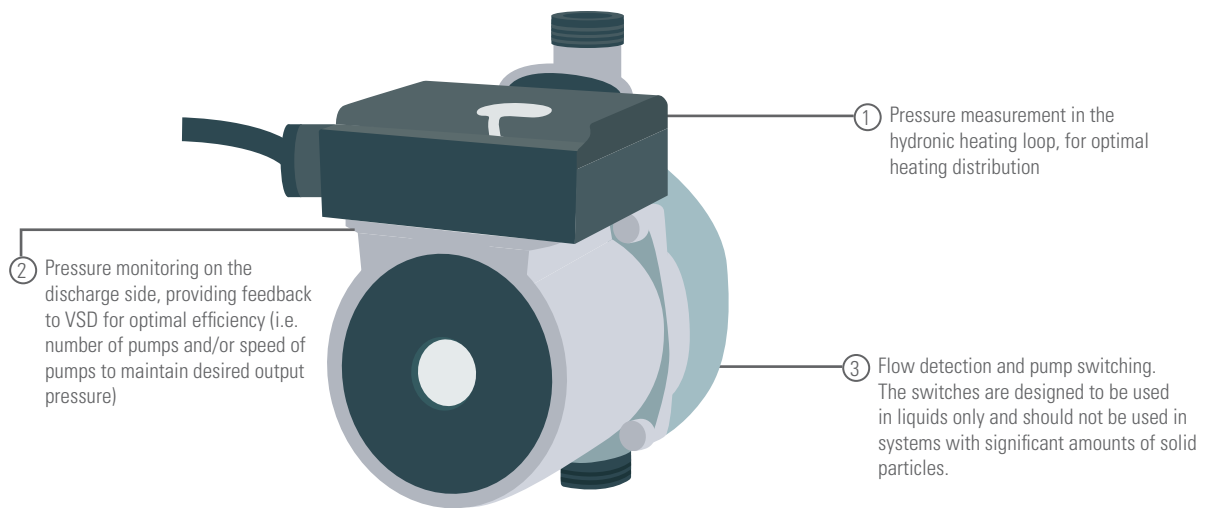
Variable speed pumps using pressure sensors from Sensata save energy by adjusting the pump needs to meet system demands. By slowing down the pumps during times of low demand, the energy consumption drops dramatically. By monitoring pump discharge pressure in real-time, pressure sensors gauge the exact pumping need and adjust motor speed accordingly, helping pump systems to reach the lowest Energy Efficiency Index.

Sensata's sensor portfolio also includes case isolated sensors which are designed specifically to operate efficiently in the high electrical noise environments present with variable frequency drive pumps.



① 	116CP, 126CP Pressure Sensor <ul style="list-style-type: none"> • Water pressure sensor, including certifications for potable water • High accuracy, REACH/RoHS compliant, 0-4 to 0-16 bar 	Pressure measurement in the hydronic heating loop, for optimal heating distribution
② 	35CP Pressure Sensors <ul style="list-style-type: none"> • Packard and M12 connector, supply: 5Vdc or 6-30Vdc • Stainless steel housing with 40bar max. pressure range, drinking water certifications available for specific products 	Pressure monitoring on the discharge side and provides feedback to VSD for optimal efficiency (i.e. number of pumps and/or speed of pumps to maintain desired output pressure)
③ 	FS Flow Switches <ul style="list-style-type: none"> • 15mm & 22mm tube versions • Low flow versions available • WRAS approval. Temperature rated to 85°C (185°F) 	Flow detection and pump switching. The switches are designed to be used in liquids only and should not be used in systems with significant amounts of solid particles.
④ 	2HMP Pressure Sensor <ul style="list-style-type: none"> • Rugged seal ideal for outdoor environments, industry leading accuracy over broad temperature range • Media and electrical isolation protects against thermal and electrical shock; outstanding EMC/ESD performance • MEMS sensing technology, low cost design for OEM applications 	Pressure monitoring at suction or discharge side
⑤ 	20PS Pressure Switch <ul style="list-style-type: none"> • Automatic Reset, single-pole, single throw switch normally open or normally closed • Stainless steel, hermetically sealed sensor, environmentally sealed or vented switch • High mechanical robustness to vibrations, high cycle life, proven reliability, custom engineered solutions 	Provides run dry protection or protection against cavitation on the suction side of the pump

Gas and Water Meters

Smart meters are a next generation gas and water meter, taking automatic, accurate readings of domestic water and gas usage, replacing old meters in homes.

Smart meters not only enable remote readings, but also allow for detection of inconsistencies, such as leaks, security alerts, and other event detection (usage spikes, hammers). Additionally, they aid in predictive maintenance and provide inputs to actuate remote shutoff, when needed.

They also support in the optimization of pump speeds across the supply network based on demand, therefore improving efficiency and reducing network operational costs.

Another large benefit of smart meters is the data access it provides to the end-user through the use of a portal dashboard or smartphone.

Sensata offers robust accurate, and certified pressure sensors for the measurement of water and gas pressure in smart meters.

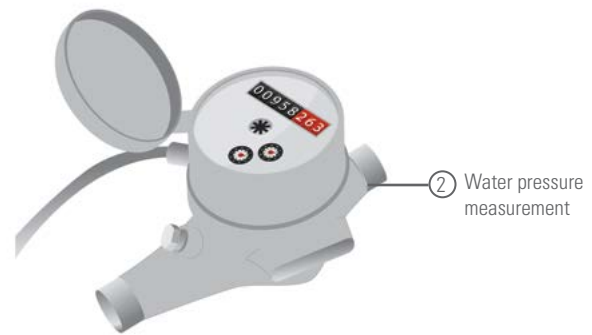

Gas Pressure Sensors

- Field proven MEMS sensor technology
- Digital I2C output with low power consumption
- Compatible with natural gas
- Small and robust plastic package

Gas pressure measurement



Ceramic Pressure Sensors

- Digital I2C output with low power consumption
- Robust and reliable to pressure spikes and waterhammer
- Compatible with drinking water safe applications

Water pressure measurement

* Other standard configurable sensors, customizable to fit your specific application demands, can be developed by Sensata Technologies. Please contact us for details.

Elevators

Sensata offers the possibility to customize each standard product to make it easier to integrate into an existing or new design.

In order for elevators to operate properly, it is imperative that they remain perfectly aligned between the cabin and floor, with absolutely no vibration between the start-up travel and arrival of the elevator cabin as well as maintain a smooth path during acceleration and deceleration. Sensata's encoders are highly accurate and provide a reliable signal that permits smooth movement of the elevator cabin.

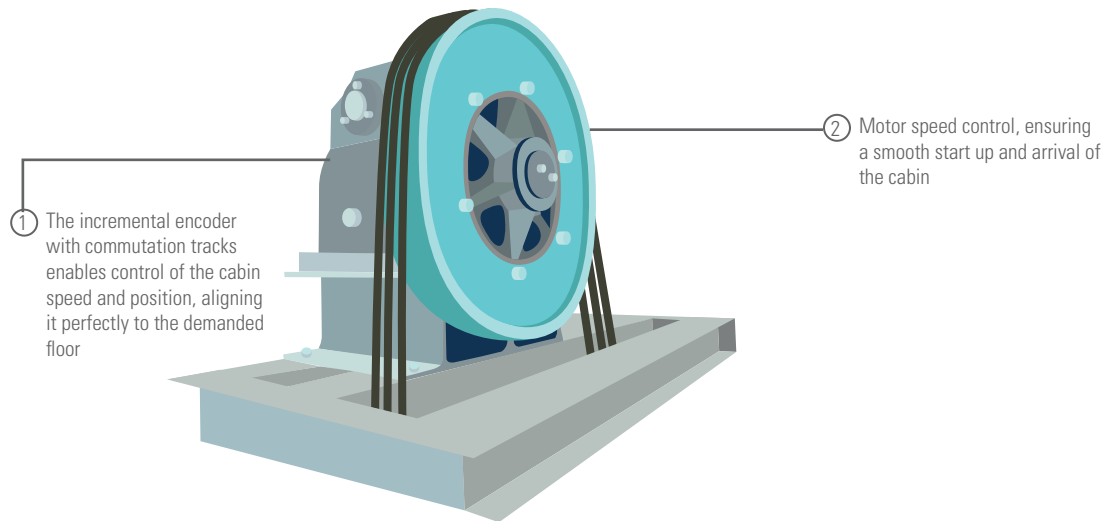

① The incremental encoder with commutation tracks enables control of the cabin speed and position, aligning it perfectly to the demanded floor

② Motor speed control, ensuring a smooth start up and arrival of the cabin

①  **KHM5 Incremental Encoder with Commutation Tracks**

- Compact encoders especially designed for motorist applications
- Robust and excellent resistance to shocks and vibrations
- High protection level IP65, high performances in a broad temperature range, universal electronic circuits

Enables control of the cabin speed and position, aligning it perfectly to the demanded floor

②  **DSM5 Incremental SIL encoder**

- Usable up to SIL3 and Cat.4/PLe according to IEC61508 / EN ISO13849a, suitable for safe motor feedback according to IEC 61800-5-2
- Robust and excellent resistance to shocks and vibrations, high performances in a broad temperature range

Controls the speed of the motor
Ensures a smooth start up and arrival of the cabin

③  **DHM5 Incremental SinCos Encoder**

- Easy programming without any specific software or hardware
- Robustness and excellent resistance to shocks and vibrations
- High resolutions available, universal electronic circuits from 5 to 30Vdc

Enables control of the cabin speed and position ensures a smooth start up and arrival of the cabin

④  **CHM5 Absolute Single Turn Encoder with Incremental Track and BiSS-C Protocol**

- Compact and robust, especially designed for heavy-duty applications
- Excellent resistance to shocks/vibrations and to extreme axial/radial loads
- Also available in SSI or parallel output and fieldbus: CanOpen, DeviceNet, Profibus

Enables control of the cabin speed and position, as well as a smooth cabin start and arrival

Access Control







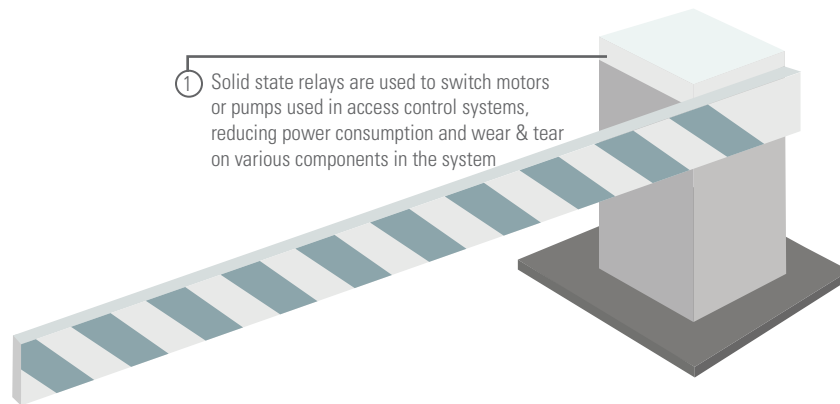

Access control applications are one of the few industrial applications all humans interact with on a daily basis. Parking gates, handicap lifts, tail lifts and roll up freight doors are few renditions of this type of application. As our cities become busier, access control applications are continuously growing in demand.

Space, environment abuse, and maintenance are three of the biggest concerns when it comes to new designs for access control applications.

New designs require smaller components so that the application itself can fit into tighter areas. Resistance to the elements as well as vibration is of great importance. As access control applications become more prevalent their components need to withstand the environments they live in. Finally, components that reduce maintenance play a large role as well.

Due to their remoteness, access control applications need to have long cycle lives and their components need to work together to preserve the lifetime of critical aspects, like the motor.



①	 EL Series Solid State Relay	<ul style="list-style-type: none"> • Compact package suitable for the space constraints of access control applications • With no moving parts, it has the durability to last in demanding applications with constant usage 	Used to switch motors or pumps used in access control systems, reducing power consumption and wear & tear on various components in the system
②	 DRC Solid State Contactor	<ul style="list-style-type: none"> • Designed for frequently switching three phase loads up to 5HP, 600VAC 7.6 Amps • It includes an interlock control that allows only forward and reverse operation in a safe mode 	Electric circuit control
③	 DRMS Motor Starter	<ul style="list-style-type: none"> • Hybrid motor starter that offers a soft start, soft stop and motor reversing functions in a compact package • It extends the lifetime of access control applications while the compact size can free up needed space 	Ensures a soft start and stop of the motor
④	 HDC Series Solid State Relay	<ul style="list-style-type: none"> • It offers less coil consumption, longer life cycle, high vibration ratings, and soft start functions versus standard electromechanical relays in access control systems using hydraulic systems 	Load switching in hydraulic systems of tail lifts, handicap ramps, and other vehicle access control applications
⑤	 PTE7100 Hermetic Analog Pressure Sensor	<ul style="list-style-type: none"> • Robust and accurate sensors, with stainless steel construction and piezo-resistive sensing technology • High vibration tolerance, temperature compensated, ideal for access control applications using hydraulic systems 	Used in the pump station that controls the rising and lowering of the unit, in access control applications using hydraulic systems
⑥	 ACW4/TCW4 Hall Effect Position Sensor	<ul style="list-style-type: none"> • Contactless position sensor with completely encapsulated electronics, which reduces troublesome maintenance and protects the sensor from demanding environment 	It measures the position of an object, which can be an arm of a gate or a roller of a door
⑦	 9850 Series Potentiometer	<ul style="list-style-type: none"> • It offers a true ratiometric reading which can be of benefit for access control applications where the power supply is far from the actual point 	Indicates the positional or operational status of the moving part
⑧	 9960 Hall Effect Position Sensor	<ul style="list-style-type: none"> • Non-contact sensor reducing maintenance call, full 360 degree travel range • Offered in a package that is rated for harsh environments 	Ensures that automated gates stay on track and avoid closing on obstacles during operation
⑨	 AC Off-Winding Motor Protector	<ul style="list-style-type: none"> • Capability to operate in wide temperature and current ranges, while providing consistent performance characteristics and excellent reliability 	Protects the three-phase motor against overheating due to constant operation

Americas

SENSATA TECHNOLOGIES INC.
529 Pleasant Street,
Attleboro, MA 02703
USA

PRESSURE SENSORS & SWITCHES
+1 (800) 350 2727
sensors@sensata.com
switches@sensata.com

TEMPERATURE SENSING
+1 (888) 438 2214
sensors@sensata.com

POSITION SENSORS AND ENCODERS
+1 (800) 350 2727
sales.beisensors@sensata.com

SOLID STATE RELAYS
+1 (877) 502 5500
sales.crydom@sensata.com

MOTORS & ACTUATORS
+1 (760) 597 7042
sales.beikimco@sensata.com

OPERATOR CONTROLS
+1 (800) 350 2727
sales.deltatech@sensata.com

ELECTRICAL PROTECTION /POWER CONTROLS
+1 (508) 236 3287
klixon@sensata.com

GIGAVAC CONTACTORS
Phone +1 (805) 684-8401
gigavac@sensata.com

CYNERGY3 COMPONENTS
+44 (0) 1202 897969
sales@cynergy3.com

Europe, Middle East & Africa

SENSATA TECHNOLOGIES HOLLAND B.V.
Jan Tinbergenstraat 80
7559 SP Hengelo
The Netherlands

PRESSURE SENSORS & SWITCHES
+359 (2) 809 1826
pressure-info.eu@sensata.com

TEMPERATURE SENSING
+359 (2) 804 7165 (Klixon)
+31 (74) 357 8156 (Airpax)
temperature-info.eu@sensata.com

POSITION SENSORS AND ENCODERS
+33 (3) 88 20 8080
position-info.eu@sensata.com

SOLID STATE RELAYS
+44 (1202) 416170
ssr-info.eu@sensata.com

MOTORS & ACTUATORS
+1 (760) 597 7042
motors-info.eu@sensata.com

OPERATOR CONTROLS
+359 (2) 809 1826
ost-info.eu@sensata.com

ELECTRICAL PROTECTION /POWER CONTROLS
+31 (74) 357 8156
temperature-info-eu@sensata.com

GIGAVAC CONTACTORS
Phone + (805) 684-8401
gigavac@sensata.com

CYNERGY3 COMPONENTS
+44 (0) 1202 897969
sales@cynergy3.com

Asia Pacific

SENSATA TECHNOLOGIES CHINA CO., LTD.
30th Floor, InterContinental Center,
100 Yu Tong Rd, Jing An District, 200070
Shanghai, China
+86 (21) 2306 1500
sales.isasia@list.sensata.com

JAPAN
+81 (45) 277 7117
sales.isasia@list.sensata.com

KOREA
+82 (31) 601 2004
sales.isasia@list.sensata.com

INDIA
+91 (80) 67920890
sales.isasia@list.sensata.com

REST OF ASIA
+886 (2) 27602006 ext 2808
sales.isasia@list.sensata.com

ELECTRICAL PROTECTION/POWER CONTROLS
+86 (21) 2306 1500
AIRPAXSH@sensata.com (Airpax)
EP_Asia_Public@list.sensata.com (Electrical
Protection)

GIGAVAC CONTACTORS
Phone + (805) 684-8401
gigavac@sensata.com

CYNERGY3 COMPONENTS
+44 (0) 1202 897969
sales@cynergy3.com